

LED LAMPS – E14
LED-BIRNE – E14
ΛΑΜΠΑ LED – E14
SVĚTELNÉ ZDROJE LED – E14



gwint E14



podstawa ceramiczna



klosz szklany



podstawa tworzywo sztuczne











E14-C37-040



E14-G45-060

D85-E27-A60-101

							
kod	symbol	EAN	opakowanie zbiorcze	barwa światła [K]	strumień światła [lm]	moc [W]	klasa energetyczna
D85-E14-C37-040-3K	E14-C37-040-3K	5900280915078	1/10/100	3000	300	4	A+
D85-E14-C37-040-4K	E14-C37-040-4K	5900280915085	1/10/100	4000	310	4	A+
D85-E14-C37-060-3K	E14-C37-060-3K	5900280913135	1/10/100	3000	450	6	A+
D85-E14-C37-060-4K	E14-C37-060-4K	5900280915023	1/10/100	4000	470	6	A+
D85-E14-G45-040-3K	E14-G45-040-3K	5900280915122	1/10/100	3000	300	4	A+
D85-E14-G45-040-4K	E14-G45-040-4K	5900280915115	1/10/100	4000	310	4	A+
D85-E14-G45-060-3K	E14-G45-060-3K	5900280913142	1/10/100	3000	450	6	A+
D85-E14-G45-060-4K	E14-G45-060-4K	5900280915030	1/10/100	4000	470	6	A+

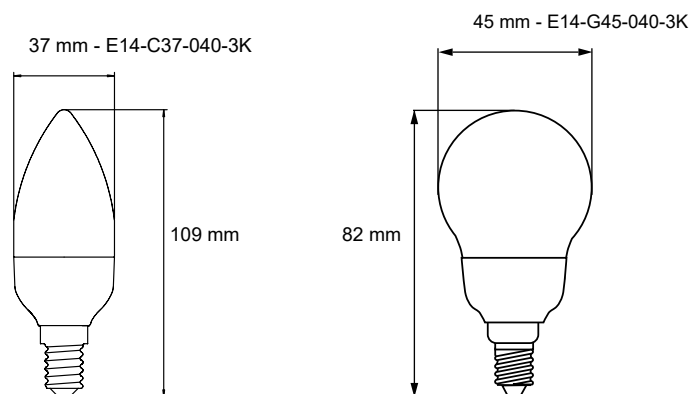

A+

